

1

2

- 1. Iguana Circo Corner (at the top)
- 2. Iguana Circo Corner (below)



Iguana Circo Corner



Iguana Circo Corner

Dimensions

CORW_Corner Wall

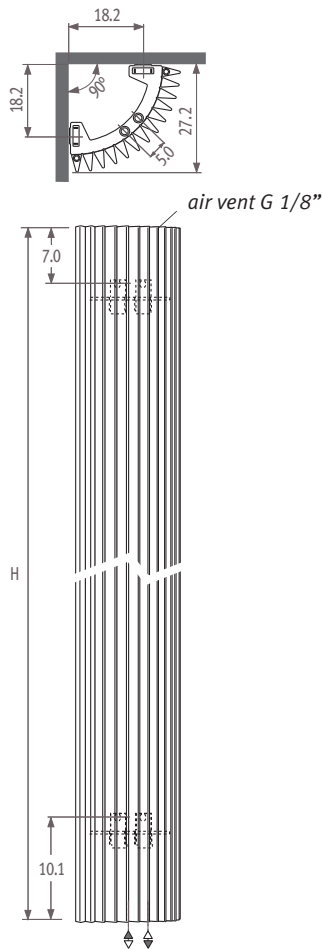

28

Position flow and return pipe

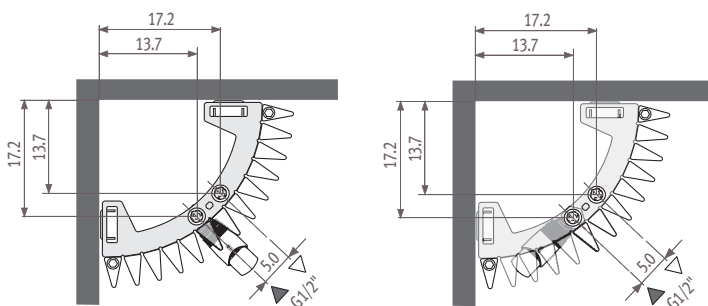

With connection sets 31-32-33-34

With connection sets 41-42

Remark: flow and return can be reordered.

Connections

Two pipe

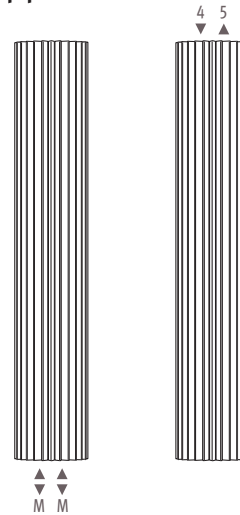

Standard connection
Code MM

Top end connection

Code 45 or 54

(1° number > flow)

When ordering a top end connection, no insert pipe should be ordered. Air vents should be positioned on the central heating pipes.

Ordering code: specify code 45 or 54 instead if MM, no surcharge.

One pipe connection

The standard radiator can be connected to a one pipe system with connection sets 41 or 42.

With a maximum of 2 radiators per heating ring.

Notice

To guarantee the output of the Iguana models and to limit the pressure drop, Jaga recommends the use of tube diameter 16/2, 18/1 or 18/2.

Dimensions options

Large shelf

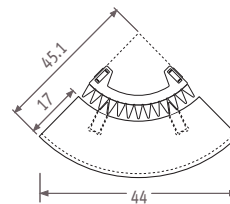

Small shelf

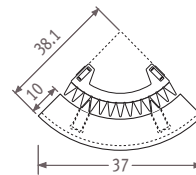

Towel rail

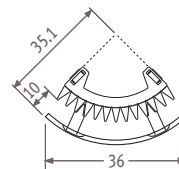

Hat rack

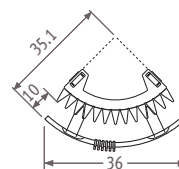

Prices & outputs

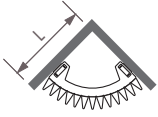

Standard delivery:

- Circo Corner with central connection MM underneath
- wall fixing
- 2 chrome-plated air vents G 1/8"

Standard colours:

- sandblast grey metallic 001
- white 301 (RAL 9010 satin)
- white 333 (RAL 9016 satin)

Iguana CORW

code height length colour conn.
ORDERING CODE:CORW. 125 027. XXX /MM

H	L 027	
125	75/65/20	723
	90/70/20	952
	st. colour other	66264
150	75/65/20	834
	90/70/20	1100
	st. colour other	66265
180	75/65/20	967
	90/70/20	1277
	st. colour other	66266
192	75/65/20	1021
	90/70/20	1350
	st. colour other	66267
200	75/65/20	1058
	90/70/20	1399
	st. colour other	66268
220	75/65/20	1149
	90/70/20	1521
	st. colour other	66269
240	75/65/20	1242
	90/70/20	1646
	st. colour other	66270



Output measured in accordance with EN442, at a water temperature of 75/65 and a room temperature of 20°C ($\Delta T=50$).

Connection sets & valves
Technical info
Correction factors
Product descriptions
Colours

Page
203
239
243
252
263

Options

Large shelf in beech veneer

CODE	
9087.040628	70348



Small shelf in beech veneer

CODE	
9087.041528	70349



Towel rail chrome-plated aluminium

CODE	
9087.043466	70350



Hat rack chrome-plated aluminium

CODE	
9087.044466	70351

