

Tempo

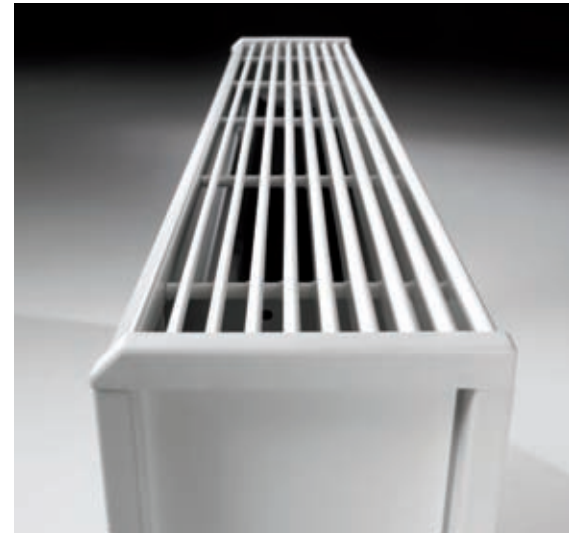



1. Optional top valve
2. Rounded synthetic corner pieces
3. Free-standing model
4. Thermostatic valve is totally concealed



Warm power, basic style

The element of choice for your Low-H₂O interior. Tempo is a pioneer when it comes to energy saving. A classic, but most certainly not classic. Its horizontally lined front panel continues to be contemporary and universal. Tempo is light, fast, accurate and can be perfectly regulated. Its characteristic look makes it a welcome addition to any interior.

Casing

- Scratch-resistant surface coating with a soft structured, satin gloss finish.
High UV resistance.
Standard colour: white RAL 9010 (101)
- The valve body and connections are totally hidden within the standard casing.
- The surface temperature of the casing always remains safe, even at a water temperature of 90 °C. Complies with the safety requirement DHSS DN4.
- The casing can be detached and attached without disassembly.
- a 10 year guarantee

Low-H₂O heat exchanger

- of pure copper and aluminium, totally non-corrosive
- a 30 year guarantee
- pressure tested: 20 bar
- with dirt-repellent and dust-proof lacquer in graphite grey (RAL 7024)
- high heat output achieved with normal and lower flow temperatures
- efficient: rapid heating up speed due to super low water content
- the optimum combination of convection and radiation

High efficiency boiler combination

Thanks to its low water content and high coefficient of heat conduction for low flow temperatures, the Tempo, with its modern Low-H₂O element, is ideal to use in combination with high efficiency boilers and/or condensing technology.

Twin Power, DBE or Oxygen?

Tempo is also available

- as DBE or Oxygen radiator: see price list "Top performers".
- with the super-powered Twin heat exchangers. The boiler temperature is on average 15% lower for equivalent radiator dimensions!

Tempo_Dimensions



TEMW_Tempo Wall

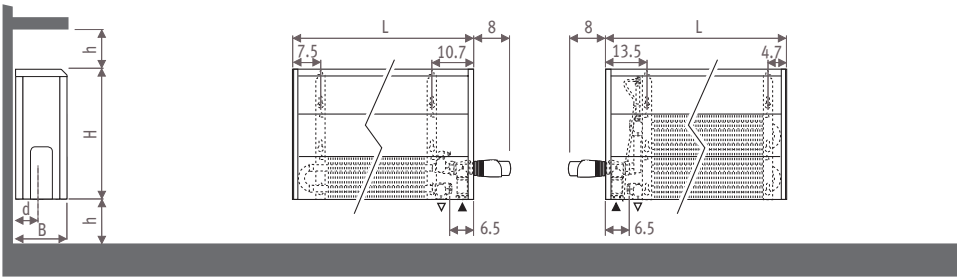

Dimensions in cm

Type	B	d	BS	h/min*
10-11	11.8	5.3	13	10
15-16	16.8	7.8	18	12
20-21	21.8	10.3	23	15

* Smaller dimensions can decrease output.

TEMF_Tempo Free-standing

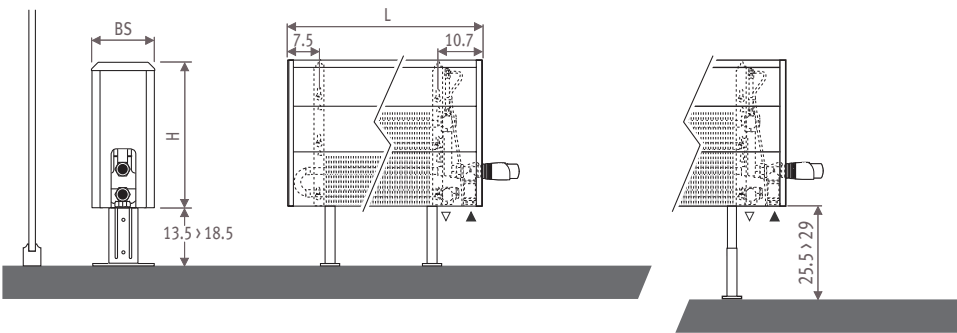

Connections

Jaga Comap valve to the wall

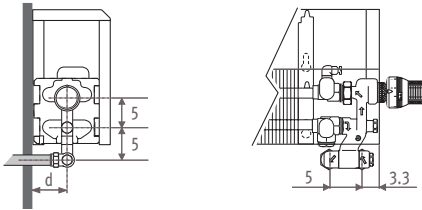

Jaga Comap valve to the floor

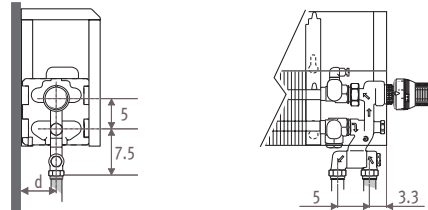

The valves offered by Jaga are totally concealed within the standard casing. Other valves may be partially visible. Detailed info: see Connection sets and valves.

Jaga Pro valve to the wall

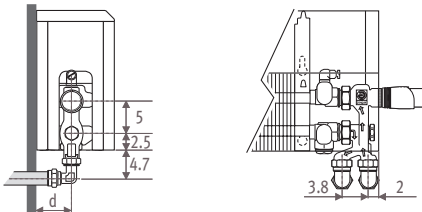

Jaga Pro valve to the floor

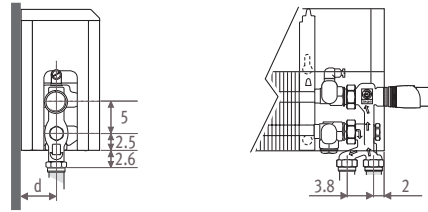

Jaga valve to the wall

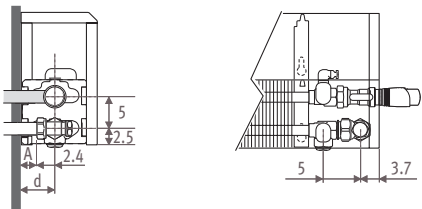

Jaga valve to the floor

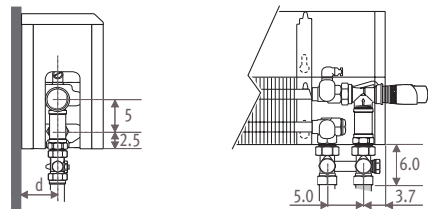

Type	d	A
10-11	5.3	2.9
15-16	7.8	5.3
20-21	10.3	7.9



Tempo_Options

Extended air vent



For easy and rapid venting.
Extended air vent for heat exchanger type 10, 15 and 20.
Standard delivered with type 11, 16 and 21.

CODE	H casing	€
5090.114078	20	
5090.114178	30	
5090.114278	40	
5090.114378	50+60	
5090.114528	70	
5090.114728	90	

Top valve

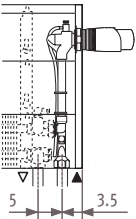

When ordering a top valve, add to the code of the Tempo /30 (top left) or /60 (top right).
Ex.: TEMW. 030 040 21.101/60

CODE	H casing	€
Tempo wall:		
5090.1300101 right	30	
5090.1300102 left	30	
5090.1300301 right	40	
5090.1300302 left	40	
5090.1300500 right and left	50	
5090.1300700 right and left	60	
5090.1300900 right and left	70	
5090.1301100 right and left	90	
Tempo free-standing:		
5090.1300100	30	
5090.1300300	40	
5090.1300500	50	

Thermostatic head not included: see Connection sets & valves page 178-179.

Brush

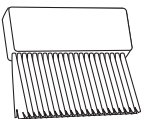

For easy cleaning of the underside of the Low-H₂O heat exchanger without detaching the casing.

CODE	€
5090.001	

Locks

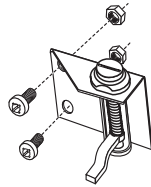

2 per casing. The casing cannot be detached without tools.

CODE	€
5095.016	

Free-standing model with feet in the colour of the appliance

The feet (standard in neutral grey lacquered) are also deliverable in the same colour as the apparatus. For this repeat the colour code after the code of the apparatus.
Ex.: TEMF. HHH LLL TT.101/101

EXTRA CHARGE	€
Length casing	colour
040 > 120 (2 feet)	
140 > 220 (3 feet)	
240 > 300 (4 feet)	

Free-standing model with extended adjustable feet

- For extended feet in neutral grey, with a height of 25.5 to 29 cm, add /AL to the ordering code. Ex.: TEMF. 020 040 10. 101/AL
- For extended feet in the same colour as the casing, with a height of 25.5 to 29 cm, add /AL to the ordering code and repeat the colour code. Ex.: TEMF. 020 040 10. 101/AL/101

EXTRA CHARGE	€	€
Length casing	grey	colour
040 > 120 (2 feet)		
140 > 220 (3 feet)		
240 > 300 (4 feet)		

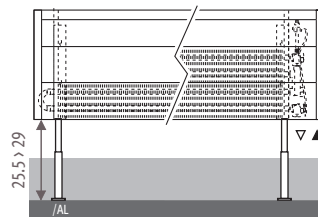

Fixing calorimeter holder

See Special Products.

DBE & Oxygen version

DBE: the smallest and most powerful radiator.

Oxygen: for healthy heat and clean air.
See price list "Top performers".



EN 442 EURO NORM Output measured in accordance with EN442, at a water temperature of 75/65°C and a room temperature of 20°C (ΔT=50).

	Page
Connection sets & valves	163
Parts	203
Special products	183
Technical info	239
Correction factors	240
Product descriptions	246

Tempo_Wall mounted model

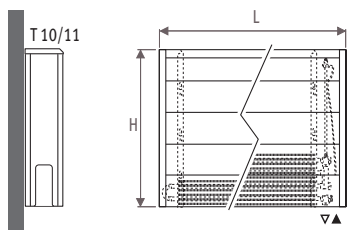

Standard delivery

- colour 101
- Low-H₂O heat exchanger type 10 or Twin type 11
- wall brackets
- complete casing
- fixing kit
- air vent 1/8": elbow (type 10) or extended (type 11)
- drain cock 1/2"

Connection

- standard connection: bottom end left or right, valve position 20 or 70
- for option top valve, add to the code of the Tempo /30 (top left) or /60 (top right)
- ex.: TEMW. 030 040 10.101/60
- for remote controlled valve: see Special products

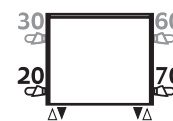

Wall mounted model_type 10

		ORDERING CODE: TEMW.																code	height	length	type	colour			
		040	050	060	070	080	090	100	110	120	140	160	180	200	220	240	260	280	300	020	040	10.	101		
H																									
020	75/65/20	262	328	393	459	524	590	655	721	786	917	1048	1179	1310	1441	1572	1703	1834	1965						
	90/70/20	339	424	508	594	678	763	847	933	1017	1186	1356	1525	1695	1864	2034	2203	2373	2542						
	€																								
030	75/65/20	330	413	496	578	661	743	826	909	991	1156	1322	1487	1652	1817	1982	2148	2313	2478						
	90/70/20	426	533	641	746	854	960	1067	1174	1280	1493	1707	1920	2134	2347	2560	2774	2987	3200						
	€																								
040	75/65/20	385	482	578	674	770	867	963	1059	1156	1348	1541	1733	1926	2119	2311	2504	2696	2889						
	90/70/20	496	621	745	869	993	1118	1242	1365	1491	1738	1987	2234	2483	2732	2980	3229	3476	3725						
	€																								
050	75/65/20	430	538	646	753	861	968	1076	1184	1291	1506	1722	1937	2152	2367	2582	2798	3013	3228						
	90/70/20	554	693	832	969	1108	1246	1385	1524	1662	1939	2217	2493	2770	3047	3324	3602	3879	4155						
	€																								
060	75/65/20	468	585	702	819	936	1053	1170	1287	1404	1638	1872	2106	2340	2574	2808	3042	3276	3510						
	90/70/20	601	752	902	1053	1203	1353	1504	1654	1804	2105	2406	2707	3007	3308	3609	3909	4210	4511						
	€																								
070	75/65/20	499	624	749	874	998	1123	1248	1373	1498	1747	1997	2246	2496	2746	2995	3245	3494	3744						
	90/70/20	640	800	961	1121	1280	1441	1601	1761	1922	2241	2562	2881	3202	3523	3842	4163	4482	4803						
	€																								
090	75/65/20	548	685	821	958	1095	1232	1369	1506	1643	1917	2190	2464	2738	3012	3286	3559	3833	4107						
	90/70/20	701	876	1050	1225	1400	1575	1750	1926	2101	2451	2800	3150	3501	3851	4201	4551	4901	5251						
	€																								

Wall mounted model Twin_type 11



		ORDERING CODE: TEMW.																code	height	length	type	colour			
		040	050	060	070	080	090	100	110	120	140	160	180	200	220	240	260	280	300	030	040	11.	101		
H																									
030	75/65/20	448	561	673	785	897	1009	1121	1233	1345	1569	1794	2018	2242	2466	2690	2915	3139	3363						
	90/70/20	583	729	875	1021	1166	1312	1458	1603	1749	2040	2333	2624	2915	3206	3498	3790	4081	4373						
	€																								
040	75/65/20	506	632	758	885	1011	1138	1264	1390	1517	1770	2022	2275	2528	2781	3034	3286	3539	3792						
	90/70/20	658	822	985	1150	1314	1479	1643	1807	1972	2301	2629	2957	3286	3615	3944	4272	4601	4930						
	€																								
050	75/65/20	554	693	832	970	1109	1247	1386	1525	1663	1940	2218	2495	2772	3049	3326	3604	3881	4158						
	90/70/20	720	901	1081	1261	1441	1621	1801	1982	2161	2522	2883	3243	3603	3963	4323	4684	5044	5404						
	€																								
060	75/65/20	598	747	896	1046	1195	1345	1494	1643	1793	2092	2390	2689	2988	3287	3586	3884	4183	4482						
	90/70/20	777	971	1164	1359	1553	1748	1941	2135	2330	2719	3106	3494	3883	4272	4660	5047	5436	5824						
	€																								
070	75/65/20	636	795	954	1113	1272	1431	1590	1749	1908	2226	2544	2862	3180	3498	3816	4134	4452	4770						
	90/70/20	826	1033	1240	1446	1653	1859	2066	2272	2479	2892	3305	3719	4132	4545	4958	5371	5784	6198						
	€																								
090	75/65/20	703	879	1055	1231	1406	1582	1758	1934	2110	2461	2813	3164	3516	3868	4219	4571	4922	5274						
	90/70/20	913	1142	1370	1599	1826	2055	2283	2512	2740	3196	3654	4109	4567	5024	5480	5937	6393	6850						
	€																								

Tempo_Wall mounted model

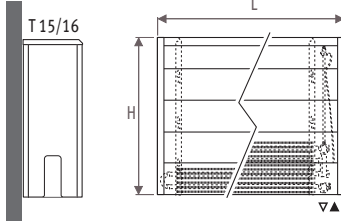

Standard delivery

- colour 101
- Low-H₂O heat exchanger type 15 or Twin type 16
- wall brackets
- complete casing
- fixing kit
- air vent 1/8": elbow (type 15) or extended (type 16)
- drain cock 1/2"

Connection

- standard connection: bottom end left or right, valve position 20 or 70
- for option top valve, add to the code of the Tempo /30 (top left) or /60 (top right)
ex.: TEMW. 030 040 15.101/60
- for remote controlled valve: see Special products

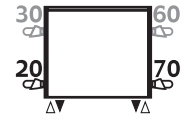

Wall mounted model_type 15

		ORDERING CODE: TEMW.																		
		code		height		length		type		colour										
		020		040		15.		101												
H		L	040	050	060	070	080	090	100	110	120	140	160	180	200	220	240	260	280	300
020	75/65/20		436	545	654	763	872	981	1090	1199	1308	1526	1744	1962	2180	2398	2616	2834	3052	3270
	90/70/20		564	705	845	986	1127	1268	1409	1550	1691	1973	2254	2536	2818	3100	3382	3663	3945	4227
			€																	
030	75/65/20		544	680	815	951	1087	1223	1359	1495	1631	1903	2174	2446	2718	2990	3262	3533	3805	4077
	90/70/20		702	877	1051	1227	1402	1577	1753	1928	2104	2455	2804	3155	3506	3857	4207	4557	4908	5259
			€																	
040	75/65/20		627	784	941	1098	1254	1411	1568	1725	1882	2195	2509	2822	3136	3450	3763	4077	4390	4704
	90/70/20		807	1009	1211	1413	1614	1816	2018	2221	2423	2826	3230	3633	4037	4441	4844	5248	5651	6055
			€																	
050	75/65/20		694	867	1040	1214	1387	1561	1734	1907	2081	2428	2774	3121	3468	3815	4162	4508	4855	5202
	90/70/20		891	1114	1336	1559	1782	2005	2227	2449	2673	3119	3563	4009	4454	4900	5346	5790	6236	6682
			€																	
060	75/65/20		746	933	1120	1306	1493	1679	1866	2053	2239	2612	2986	3359	3732	4105	4478	4852	5225	5598
	90/70/20		956	1196	1435	1674	1913	2152	2392	2631	2870	3348	3827	4305	4783	5261	5739	6219	6697	7175
			€																	
070	75/65/20		789	986	1183	1380	1578	1775	1972	2169	2366	2761	3155	3550	3944	4338	4733	5127	5522	5916
	90/70/20		1009	1261	1513	1765	2018	2270	2522	2774	3026	3532	4035	4541	5045	5549	6054	6558	7063	7567
			€																	
090	75/65/20		848	1060	1272	1484	1696	1908	2120	2332	2544	2968	3392	3816	4240	4664	5088	5512	5936	6360
	90/70/20		1080	1350	1620	1890	2160	2430	2700	2970	3240	3780	4320	4860	5400	5940	6479	7019	7559	8099
			€																	

Wall mounted model Twin_type 16



		ORDERING CODE: TEMW.																		
		code		height		length		type		colour										
		030		040		16.		101												
H		L	040	050	060	070	080	090	100	110	120	140	160	180	200	220	240	260	280	300
030	75/65/20		592	740	888	1036	1184	1332	1480	1628	1776	2072	2368	2664	2960	3256	3552	3848	4144	4440
	90/70/20		772	965	1158	1351	1544	1737	1930	2123	2316	2702	3088	3474	3860	4246	4632	5018	5404	5790
			€																	
040	75/65/20		680	850	1020	1190	1360	1530	1700	1870	2040	2380	2720	3060	3400	3740	4080	4420	4760	5100
	90/70/20		887	1109	1331	1553	1775	1997	2218	2440	2662	3106	3550	3993	4437	4881	5324	5768	6212	6655
			€																	
050	75/65/20		759	949	1139	1329	1518	1708	1898	2088	2278	2657	3037	3416	3796	4176	4555	4935	5314	5694
	90/70/20		991	1239	1487	1736	1982	2231	2479	2727	2975	3470	3966	4461	4957	5454	5949	6445	6940	7436
			€																	
060	75/65/20		834	1042	1250	1459	1667	1876	2084	2292	2501	2918	3334	3751	4168	4585	5002	5418	5835	6252
	90/70/20		1090	1362	1634	1907	2179	2452	2724	2995	3269	3813	4357	4902	5447	5992	6537	7081	7626	8171
			€																	
070	75/65/20		904	1130	1356	1582	1808	2034	2260	2486	2712	3164	3616	4068	4520	4972	5424	5876	6328	6780
	90/70/20		1182	1478	1773	2069	2365	2660	2956	3251	3547	4138	4729	5320	5911	6503	7094	7685	8276	8867
			€																	
090	75/65/20		1038	1298	1558	1817	2077	2336	2596	2856	3115	3634	4154	4673	5192	5711	6230	6750	7269	7788
	90/70/20		1360	1700	2041	2380	2720	3060	3400	3741	4080	4760	5441	6120	6800	7480	8160	8841	9521	10200
			€																	

Tempo_Wall mounted model



46

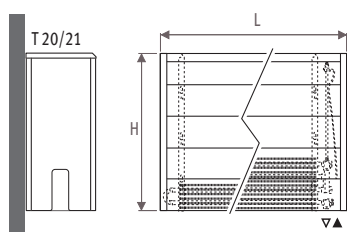

Standard delivery

- colour 101
- Low-H₂O heat exchanger type 20 or Twin type 21
- wall brackets
- complete casing
- fixing kit
- air vent 1/8": elbow (type 20) or extended (type 21)
- drain cock 1/2"

Connection

- standard connection: bottom end left or right, valve position 20 or 70
- for option top valve, add to the code of the Tempo /30 (top left) or /60 (top right)
- ex.: TEMW. 030 040 20.101/60
- for remote controlled valve: see Special products

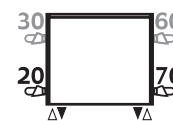

Wall mounted model_type 20

ORDERING CODE: TEMW. *code* *height* *length* *type* *colour*
020 040 20. 101

H		L 040	050	060	070	080	090	100	110	120	140	160	180	200	220	240	260	280	300
020	75/65/20	613	766	919	1072	1226	1379	1532	1685	1838	2145	2451	2758	3064	3370	3677	3983	4290	4596
	90/70/20	792	990	1188	1386	1585	1783	1980	2178	2376	2773	3168	3565	3961	4356	4753	5149	5546	5941
	€																		
030	75/65/20	762	953	1144	1334	1525	1715	1906	2097	2287	2668	3050	3431	3812	4193	4574	4956	5337	5718
	90/70/20	983	1229	1476	1721	1967	2212	2458	2705	2950	3441	3934	4425	4917	5408	5900	6392	6884	7375
	€																		
040	75/65/20	878	1098	1318	1537	1757	1976	2196	2416	2635	3074	3514	3953	4392	4831	5270	5710	6149	6588
	90/70/20	1130	1413	1696	1978	2261	2543	2826	3109	3391	3956	4523	5088	5653	6218	6783	7349	7914	8479
	€																		
050	75/65/20	970	1213	1455	1698	1940	2183	2425	2668	2910	3395	3880	4365	4850	5335	5820	6305	6790	7275
	90/70/20	1246	1558	1869	2181	2492	2804	3115	3427	3738	4361	4984	5607	6230	6853	7475	8098	8721	9344
	€																		
060	75/65/20	1043	1304	1565	1826	2086	2347	2608	2869	3130	3651	4173	4694	5216	5738	6259	6781	7302	7824
	90/70/20	1337	1671	2006	2340	2673	3008	3343	3677	4012	4679	5348	6016	6685	7354	8022	8691	9359	10028
	€																		
070	75/65/20	1101	1377	1652	1927	2202	2478	2753	3028	3304	3854	4405	4955	5506	6057	6607	7158	7708	8259
	90/70/20	1408	1761	2113	2464	2816	3169	3521	3872	4225	4929	5633	6337	7041	7746	8449	9154	9857	10562
	€																		
090	75/65/20	1183	1479	1774	2070	2366	2661	2957	3253	3548	4140	4731	5323	5914	6505	7097	7688	8280	8871
	90/70/20	1507	1883	2259	2636	3013	3389	3766	4143	4518	5272	6025	6779	7531	8284	9038	9791	10544	11297
	€																		

Wall mounted model Twin_type 21



ORDERING CODE: TEMW. *code* *height* *length* *type* *colour*
030 040 21. 101

H		L 040	050	060	070	080	090	100	110	120	140	160	180	200	220	240	260	280	300
030	75/65/20	779	974	1169	1364	1558	1753	1948	2143	2338	2727	3117	3506	3896	4286	4675	5065	5454	5844
	90/70/20	1018	1273	1528	1783	2036	2291	2546	2801	3056	3564	4074	4582	5092	5601	6110	6619	7128	7637
	€																		
040	75/65/20	910	1137	1364	1592	1819	2047	2274	2501	2729	3184	3638	4093	4548	5003	5458	5912	6367	6822
	90/70/20	1191	1488	1786	2084	2381	2680	2977	3274	3572	4168	4762	5358	5953	6549	7145	7739	8335	8930
	€																		
050	75/65/20	1033	1291	1549	1807	2066	2324	2582	2840	3098	3615	4131	4648	5164	5680	6197	6713	7230	7746
	90/70/20	1354	1692	2031	2369	2708	3047	3385	3723	4061	4739	5416	6093	6770	7446	8124	8800	9478	10155
	€																		
060	75/65/20	1153	1441	1729	2017	2306	2594	2882	3170	3458	4035	4611	5188	5764	6340	6917	7493	8070	8646
	90/70/20	1514	1892	2270	2648	3027	3406	3784	4162	4540	5297	6054	6811	7567	8324	9081	9837	10595	11351
	€																		
070	75/65/20	1271	1589	1906	2224	2542	2859	3177	3495	3812	4448	5083	5719	6354	6989	7625	8260	8896	9531
	90/70/20	1671	2089	2506	2924	3342	3759	4177	4595	5012	5848	6683	7519	8354	9189	10025	10860	11696	12531
	€																		
090	75/65/20	1508	1885	2262	2639	3016	3393	3770	4147	4524	5278	6032	6786	7540	8294	9048	9802	10556	11310
	90/70/20	1989	2486	2983	3480	3978	4475	4972	5469	5967	6961	7955	8950	9944	10939	11933	12927	13922	14916
	€																		

Tempo_Free-standing model

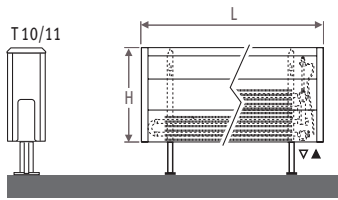

Standard delivery type 10

- colour 101
- Low-H₂O heat exchanger type 10
- brackets
- complete casing
- adjustable feet in neutral grey
- air vent elbow 1/8"
- drain cock 1/2"

Standard delivery type 11

- colour 101
- Twin Low-H₂O heat exchanger type 11
- brackets
- complete casing
- adjustable feet in neutral grey
- extended air vent 1/8"
- drain cock 1/2"

Connection

Top valve: add /30 (left) or /60 (right).
Ex.: TEMF. 030 040 10.101/60

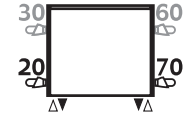

Free-standing model_type 10

		ORDERING CODE: TEMF.																		
		code		height		length		type		colour										
H	L	040	050	060	070	080	090	100	110	120	140	160	180	200	220	240	260	280	300	
020	75/65/20	262	328	393	459	524	590	655	721	786	917	1048	1179	1310	1441	1572	1703	1834	1965	
	90/70/20	339	424	508	594	678	763	847	933	1017	1186	1356	1525	1695	1864	2034	2203	2373	2542	
		€																		
030	75/65/20	330	413	496	578	661	743	826	909	991	1156	1322	1487	1652	1817	1982	2148	2313	2478	
	90/70/20	426	533	641	746	854	960	1067	1174	1280	1493	1707	1920	2134	2347	2560	2774	2987	3200	
		€																		
040	75/65/20	385	482	578	674	770	867	963	1059	1156	1348	1541	1733	1926	2119	2311	2504	2696	2889	
	90/70/20	496	621	745	869	993	1118	1242	1365	1491	1738	1987	2234	2483	2732	2980	3229	3476	3725	
		€																		
050	75/65/20	430	538	646	753	861	968	1076	1184	1291	1506	1722	1937	2152	2367	2582	2798	3013	3228	
	90/70/20	554	693	832	969	1108	1246	1385	1524	1662	1939	2217	2493	2770	3047	3324	3602	3879	4155	
		€																		

Free-standing model Twin_type 11



		ORDERING CODE: TEMF.																		
		code		height		length		type		colour										
H	L	040	050	060	070	080	090	100	110	120	140	160	180	200	220	240	260	280	300	
030	75/65/20	448	561	673	785	897	1009	1121	1233	1345	1569	1794	2018	2242	2466	2690	2915	3139	3363	
	90/70/20	583	729	875	1021	1166	1312	1458	1603	1749	2040	2333	2624	2915	3206	3498	3790	4081	4373	
		€																		
040	75/65/20	506	632	758	885	1011	1138	1264	1390	1517	1770	2022	2275	2528	2781	3034	3286	3539	3792	
	90/70/20	658	822	985	1150	1314	1479	1643	1807	1972	2301	2629	2957	3286	3615	3944	4272	4601	4930	
		€																		
050	75/65/20	554	693	832	970	1109	1247	1386	1525	1663	1940	2218	2495	2772	3049	3326	3604	3881	4158	
	90/70/20	720	901	1081	1261	1441	1621	1801	1982	2161	2522	2883	3243	3603	3963	4323	4684	5044	5404	
		€																		

Tempo_Free-standing model



48

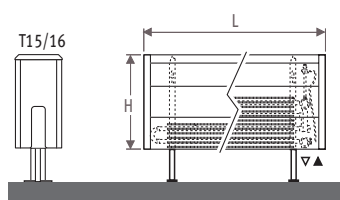

Standard delivery type 15

- colour 101
- Low-H₂O heat exchanger type 15
- brackets
- complete casing
- adjustable feet in neutral grey
- air vent elbow 1/8"
- drain cock 1/2"

Standard delivery type 16

- colour 101
- Twin Low-H₂O heat exchanger type 16
- brackets
- complete casing
- adjustable feet in neutral grey
- extended air vent 1/8"
- drain cock 1/2"

Connection

Top valve: add /30 (left) or /60 (right).

Ex.: TEMF. 030 040 15.101/60

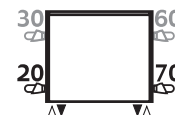

Free-standing model_type 15

ORDERING CODE: TEMF. *code* *height* *length* *type* *colour*
020 040 15. 101

H		L	040	050	060	070	080	090	100	110	120	140	160	180	200	220	240	260	280	300
020	75/65/20		436	545	654	763	872	981	1090	1199	1308	1526	1744	1962	2180	2398	2616	2834	3052	3270
	90/70/20		564	705	845	986	1127	1268	1409	1550	1691	1973	2254	2536	2818	3100	3382	3663	3945	4227
	€																			
030	75/65/20		544	680	815	951	1087	1223	1359	1495	1631	1903	2174	2446	2718	2990	3262	3533	3805	4077
	90/70/20		702	877	1051	1227	1402	1577	1753	1928	2104	2455	2804	3155	3506	3857	4207	4557	4908	5259
	€																			
040	75/65/20		627	784	941	1098	1254	1411	1568	1725	1882	2195	2509	2822	3136	3450	3763	4077	4390	4704
	90/70/20		807	1009	1211	1413	1614	1816	2018	2221	2423	2826	3230	3633	4037	4441	4844	5248	5651	6055
	€																			
050	75/65/20		694	867	1040	1214	1387	1561	1734	1907	2081	2428	2774	3121	3468	3815	4162	4508	4855	5202
	90/70/20		891	1114	1336	1559	1782	2005	2227	2449	2673	3119	3563	4009	4454	4900	5346	5790	6236	6682
	€																			

Free-standing model Twin_type 16



ORDERING CODE: TEMF. *code* *height* *length* *type* *colour*
030 040 16. 101

H		L	040	050	060	070	080	090	100	110	120	140	160	180	200	220	240	260	280	300
030	75/65/20		592	740	888	1036	1184	1332	1480	1628	1776	2072	2368	2664	2960	3256	3552	3848	4144	4440
	90/70/20		772	965	1158	1351	1544	1737	1930	2123	2316	2702	3088	3474	3860	4246	4632	5018	5404	5790
	€																			
040	75/65/20		680	850	1020	1190	1360	1530	1700	1870	2040	2380	2720	3060	3400	3740	4080	4420	4760	5100
	90/70/20		887	1109	1331	1553	1775	1997	2218	2440	2662	3106	3550	3993	4437	4881	5324	5768	6212	6655
	€																			
050	75/65/20		759	949	1139	1329	1518	1708	1898	2088	2278	2657	3037	3416	3796	4176	4555	4935	5314	5694
	90/70/20		991	1239	1487	1736	1982	2231	2479	2727	2975	3470	3966	4461	4957	5454	5949	6445	6940	7436
	€																			

Tempo_Free-standing model

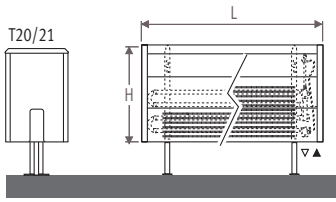

Standard delivery type 20

- colour 101
- Low-H₂O heat exchanger type 20
- brackets
- complete casing
- adjustable feet in neutral grey
- air vent elbow 1/8"
- drain cock 1/2"

Standard delivery type 21

- colour 101
- Twin Low-H₂O heat exchanger type 21
- brackets
- complete casing
- adjustable feet in neutral grey
- extended air vent 1/8"
- drain cock 1/2"

Connection

Top valve: add /30 (left) or /60 (right).
Ex.: TEMF. 030 040 20.101/60

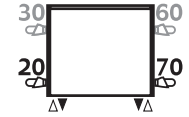

Free-standing model_type 20

		ORDERING CODE: TEMF.																	
		code		height		length		type		colour									
H		040	050	060	070	080	090	100	110	120	140	160	180	200	220	240	260	280	300
020	75/65/20	613	766	919	1072	1226	1379	1532	1685	1838	2145	2451	2758	3064	3370	3677	3983	4290	4596
	90/70/20	792	990	1188	1386	1585	1783	1980	2178	2376	2773	3168	3565	3961	4356	4753	5149	5546	5941
	€																		
030	75/65/20	762	953	1144	1334	1525	1715	1906	2097	2287	2668	3050	3431	3812	4193	4574	4956	5337	5718
	90/70/20	983	1229	1476	1721	1967	2212	2458	2705	2950	3441	3934	4425	4917	5408	5900	6392	6884	7375
	€																		
040	75/65/20	878	1098	1318	1537	1757	1976	2196	2416	2635	3074	3514	3953	4392	4831	5270	5710	6149	6588
	90/70/20	1130	1413	1696	1978	2261	2543	2826	3109	3391	3956	4523	5088	5653	6218	6783	7349	7914	8479
	€																		
050	75/65/20	970	1213	1455	1698	1940	2183	2425	2668	2910	3395	3880	4365	4850	5335	5820	6305	6790	7275
	90/70/20	1246	1558	1869	2181	2492	2804	3115	3427	3738	4361	4984	5607	6230	6853	7475	8098	8721	9344
	€																		

Free-standing model Twin_type 21



		ORDERING CODE: TEMF.																	
		code		height		length		type		colour									
H		040	050	060	070	080	090	100	110	120	140	160	180	200	220	240	260	280	300
030	75/65/20	779	974	1169	1364	1558	1753	1948	2143	2338	2727	3117	3506	3896	4286	4675	5065	5454	5844
	90/70/20	1018	1273	1528	1783	2036	2291	2546	2801	3056	3564	4074	4582	5092	5601	6110	6619	7128	7637
	€																		
040	75/65/20	910	1137	1364	1592	1819	2047	2274	2501	2729	3184	3638	4093	4548	5003	5458	5912	6367	6822
	90/70/20	1191	1488	1786	2084	2381	2680	2977	3274	3572	4168	4762	5358	5953	6549	7145	7739	8335	8930
	€																		
050	75/65/20	1033	1291	1549	1807	2066	2324	2582	2840	3098	3615	4131	4648	5164	5680	6197	6713	7230	7746
	90/70/20	1354	1692	2031	2369	2708	3047	3385	3723	4061	4739	5416	6093	6770	7446	8124	8800	9478	10155
	€																		